

Article number: 03446110

Description: Fluro Heavy Duty Spherical Plain Bearing GE 110 GW-2RS  
Hole Ø110

Note: 110

## Measures

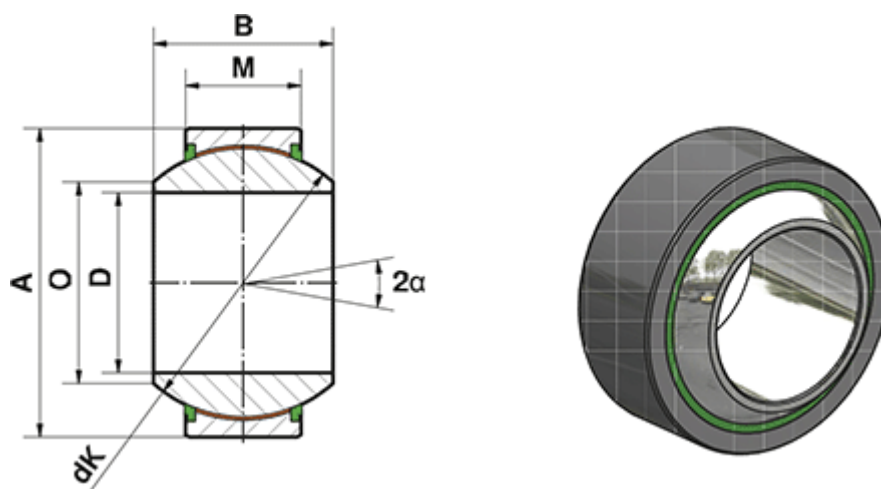

	= -	Dynamic load C (kN) = 2685
	= -	M = 70
	= -	O = 124.8
A	= 180	Static load C0 (kN) = 4475
a (degrees)	= 12	Weight (g) = 9800
B	= 100	
D	= 110	
dK	= 160	